

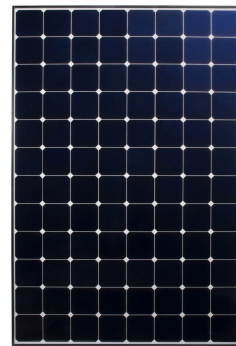

### HIGH PERFORMANCE & EXCELLENT DURABILITY



E20 - 327 PANEL



- **20.4% efficiency**  
Ideal for roofs where space is at a premium or where future expansion might be needed.
- **High performance**  
Delivers excellent performance in real world conditions, such as high temperatures, clouds and low light.<sup>1, 2, 3</sup>
- **Proven value**  
Designed for residential rooftops, E-Series panels deliver the features, value and performance for any home.

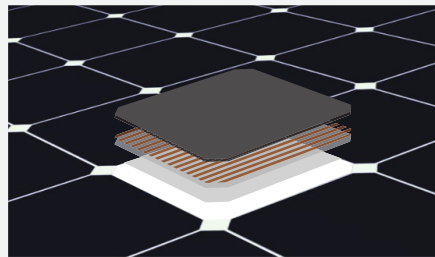

**Moxeon® Solar Cells: Fundamentally better.**  
Engineered for performance, designed for durability.

**Engineered for peace of mind**  
Designed to deliver consistent, trouble-free energy over a very long lifetime.<sup>4,5</sup>

**Designed for durability**  
The SunPower® Moxeon Solar Cell is the only cell built on a solid copper foundation. Virtually impervious to the corrosion and cracking that degrade Conventional Panels.<sup>4,5</sup>

**#1 Ranked** in Fraunhofer durability test.<sup>10</sup>  
**100% power** maintained in Atlas 25+ comprehensive PVDI Durability test.<sup>11</sup>

### HIGH EFFICIENCY<sup>6</sup>

Generate more energy per square foot

E-Series residential panels convert more sunlight to electricity producing 36% more power per panel,<sup>1</sup> and 60% more energy per square foot over 25 years.<sup>3,4</sup>

### HIGH ENERGY PRODUCTION<sup>7</sup>

Produce more energy per rated watt

High year one performance delivers 7-9% more energy per rated watt.<sup>3</sup> This advantage increases over time, producing 20% more energy over the first 25 years to meet your needs.<sup>4</sup>

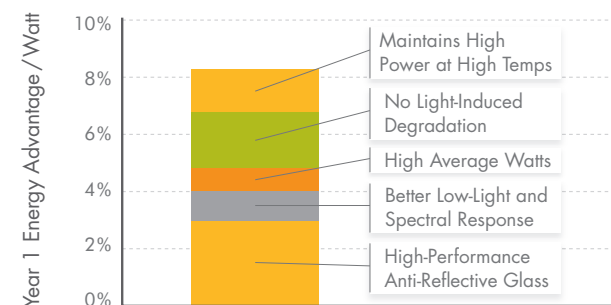
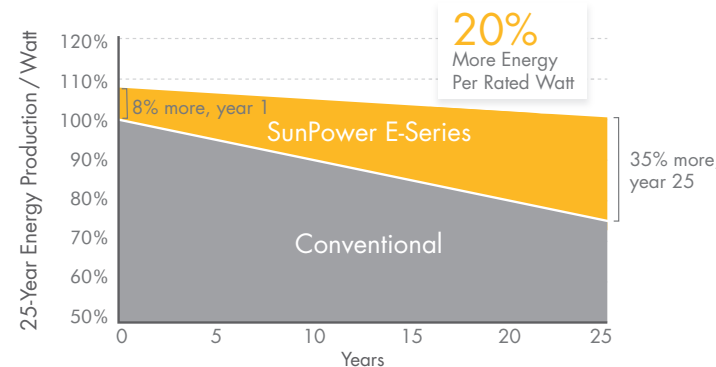

### SUNPOWER OFFERS THE BEST COMBINED POWER AND PRODUCT WARRANTY

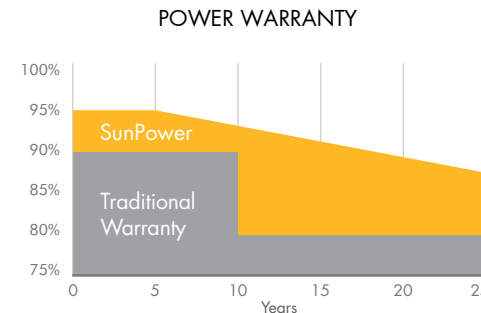

More guaranteed power: 95% for first 5 years, -0.4%/yr. to year 25.<sup>8</sup>

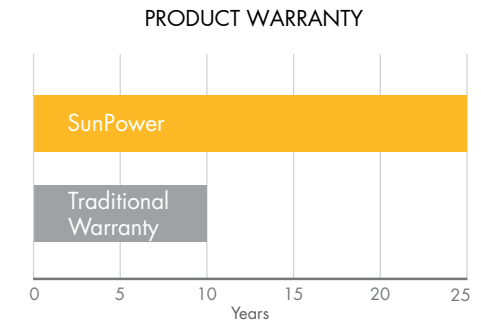

Combined Power and Product Defect 25 year coverage that includes panel replacement costs.<sup>9</sup>

ELECTRICAL DATA		
	E20-327	E19-320
Nominal Power <sup>12</sup> (P <sub>nom</sub> )	327 W	320 W
Power Tolerance	+5/-0%	+5/-0%
Avg. Panel Efficiency <sup>13</sup>	20.4%	19.9%
Rated Voltage (V <sub>mpp</sub> )	54.7 V	54.7 V
Rated Current (I <sub>mpp</sub> )	5.98 A	5.86 A
Open-Circuit Voltage (V <sub>oc</sub> )	64.9 V	64.8 V
Short-Circuit Current (I <sub>sc</sub> )	6.46 A	6.24 A
Maximum System Voltage	600 V UL & 1000 V IEC	
Maximum Series Fuse	20 A	
Power Temp Coef. (P <sub>mpp</sub> )	-0.38% / °C	
Voltage Temp Coef. (V <sub>oc</sub> )	-176.6 mV / °C	
Current Temp Coef. (I <sub>sc</sub> )	3.5 mA / °C	

OPERATING CONDITION AND MECHANICAL DATA	
Temperature	-40°F to +185°F (-40°C to +85°C)
Max load	Wind: 50 psf, 2400 Pa, 245 kg/m <sup>2</sup> front & back Snow: 112 psf, 5400 Pa, 550kg/m <sup>2</sup> front
Impact resistance	1 inch (25 mm) diameter hail at 52 mph (23 m/s)
Appearance	Class A
Solar Cells	96 Monocrystalline Moxeon Gen II Cells
Tempered Glass	High Transmission Tempered Anti-Reflective
Junction Box	IP-65 Rated
Connectors	MC4 Compatible
Frame	Class 1 black anodized, highest AAMA Rating
Weight	41 lbs (18.6 kg)

TESTS AND CERTIFICATIONS	
Standard tests	UL 1703, IEC 61215, IEC 61730
Quality tests	ISO 9001:2008, ISO 14001:2004
EHS Compliance	RoHS, OHSAS 18001:2007, lead-free, PV Cycle
Ammonia test	IEC 62716
Salt Spray test	IEC 61701 (passed maximum severity)
PID test	Potential-Induced Degradation free: 1000V <sup>10</sup>
Available listings	CEC, JET, KEMCO, MCS, FSEC, CSA, UL, TUV

#### REFERENCES:

- All comparisons are SPR-E20-327 vs. a representative conventional panel: 240W, approx. 1.6 m<sup>2</sup>, 15% efficiency.
- PVEvolution Labs "SunPower Shading Study," Feb 2013.
- Typically 7-9% more energy per watt, BEW/DNV Engineering "SunPower Yield Report," Jan 2013.
- SunPower 0.25%/yr degradation vs. 1.0%/yr conv. panel. Campeau, Z. et al. "SunPower Module Degradation Rate," SunPower white paper, Feb 2013; Jordan, Dirk "SunPower Test Report," NREL, Oct 2012.
- "SunPower Module 40-Year Useful Life" SunPower white paper, Feb 2013. Useful life is 99 out of 100 panels operating at more than 70% of rated power.
- Out of all 2600 panels listed in Photon International, Feb 2012.
- 8% more energy than the average of the top 10 panel companies tested in 2012 (151 panels, 102 companies), Photon International, March 2013.
- Compared with the top 15 manufacturers. SunPower Warranty Review, Feb 2013.
- Some exclusions apply. See warranty for details.
- 5 of top 8 panel manufacturers were tested by Fraunhofer ISE, "PV Module Durability Initiative Public Report," Feb 2013.
- Compared with the non-stress-tested control panel. Atlas 25+ Durability test report, Feb 2013.
- Standard Test Conditions (1000 W/m<sup>2</sup> irradiance, AM 1.5, 25° C).
- Based on average of measured power values during production.

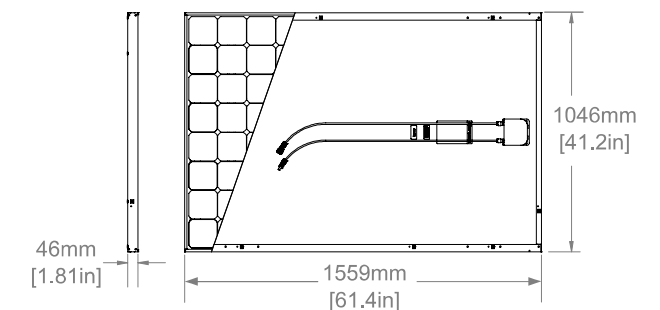

See <http://www.sunpowercorp.com/facts> for more reference information.

For further details, see supplementary specs: [www.sunpowercorp.com/datasheets](http://www.sunpowercorp.com/datasheets). Read safety and installation instructions before using this product.

© April 2013 SunPower Corporation. All rights reserved. SUNPOWER, the SUNPOWER logo, MAXEON, MORE ENERGY. FOR LIFE., and SIGNATURE are trademarks or registered trademarks of SunPower Corporation. Specifications included in this datasheet are subject to change without notice.